

潮岬灯台 二代目 S, 1/100

和歌山県東牟婁郡串本町(潮岬)

灯台の大きさ

高さ：建物 22.51m 光り 水面から49.47m

灯塔の太さ：円筒形 5.5m

光りのとどく距離：130万カデラ 19.0海里(約35Km)

光りかた：15秒に1回白く光る(LB-H120型)

設置年月：明治6年9月15日



潮岬灯台

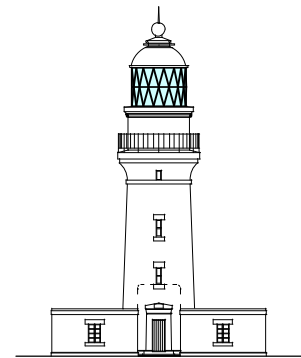

灯台姿図 1 / 500

- — — — — 山折り線
- — — — — 谷折り線
- - - - - のりしろ

灯塔

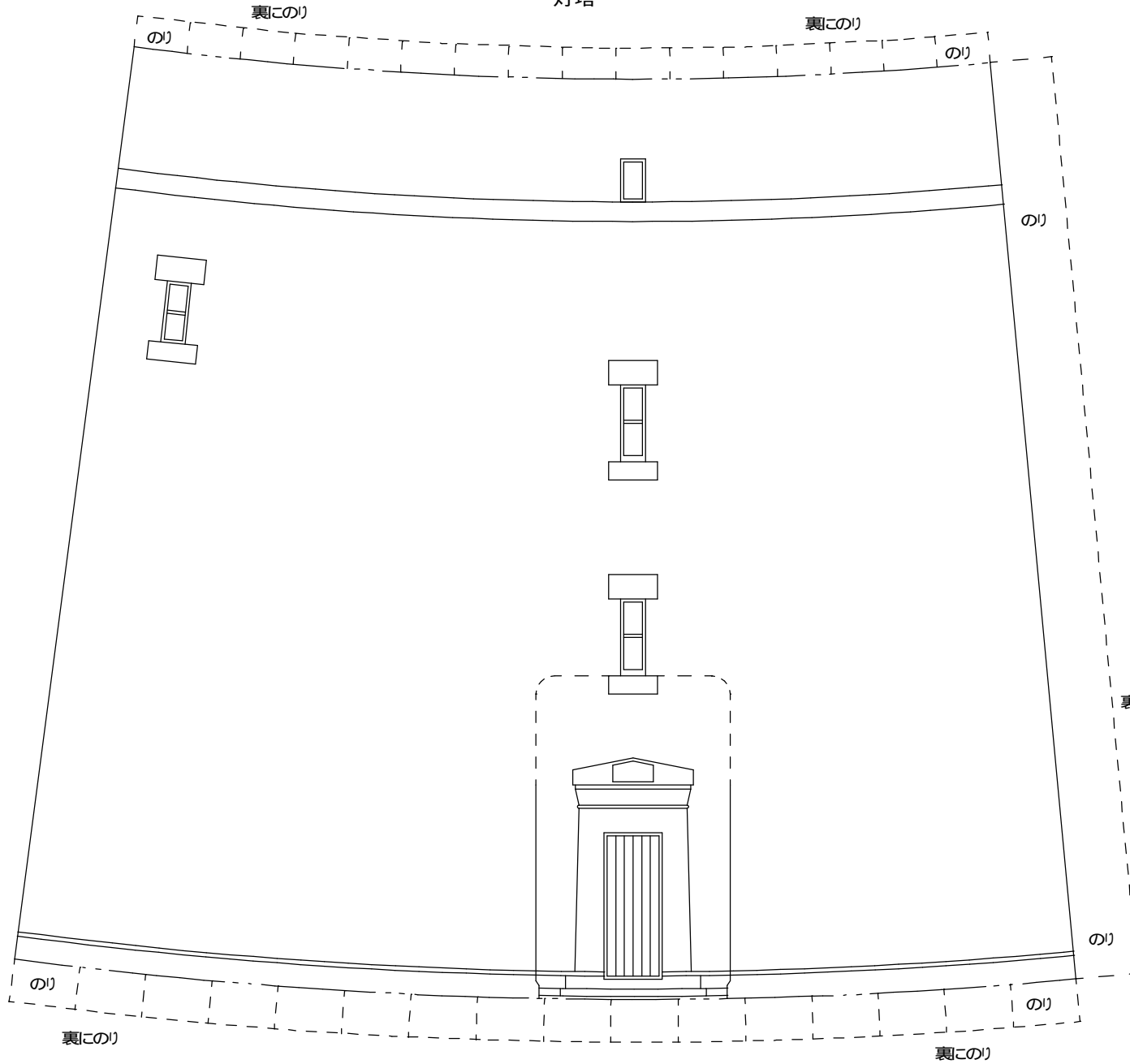

灯塔上部飾り

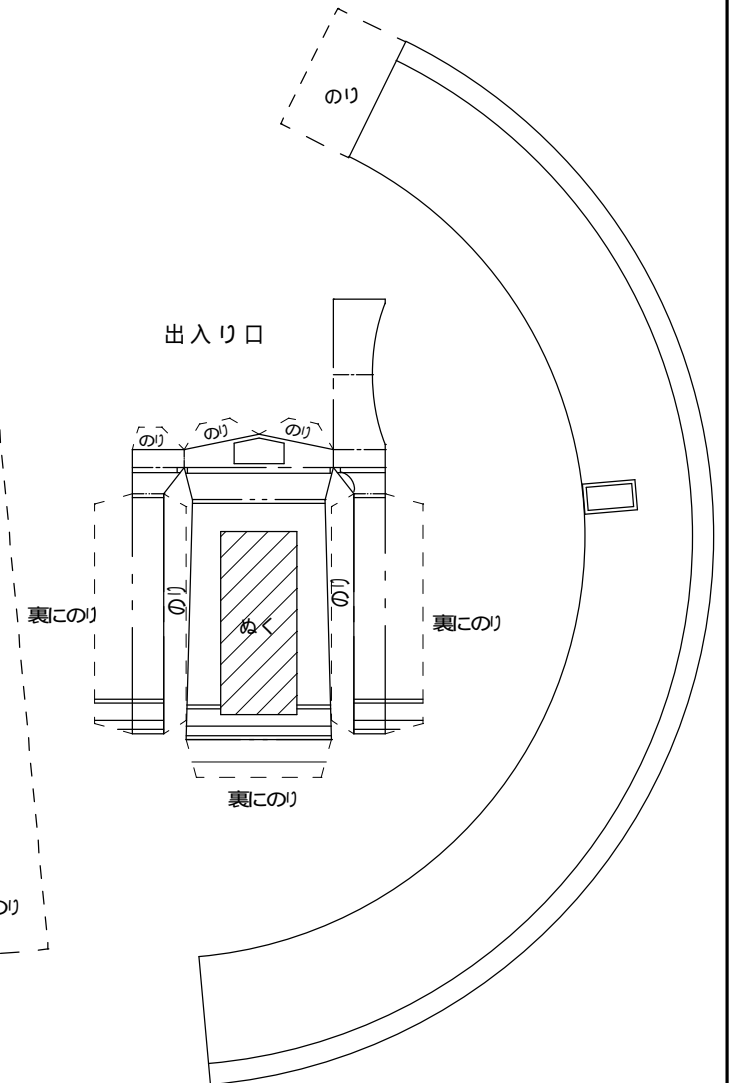

付属舎壁
(右)

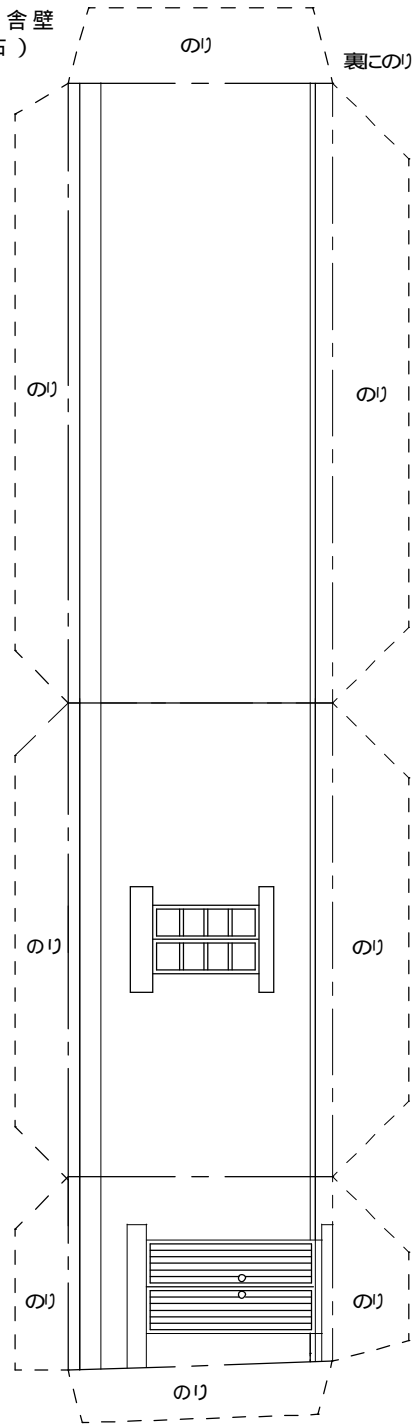

付属舎壁(左)
裏このり

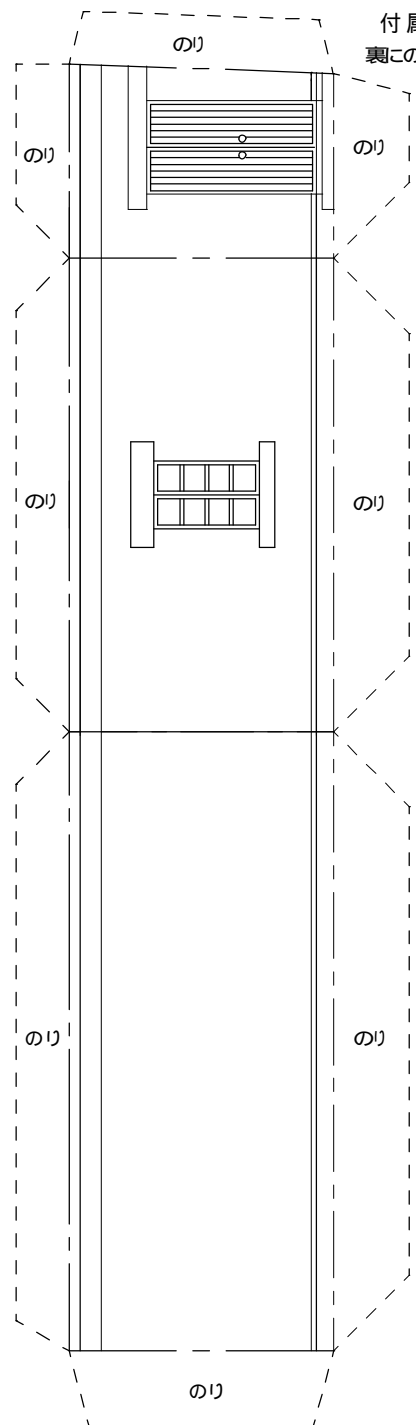

屋根

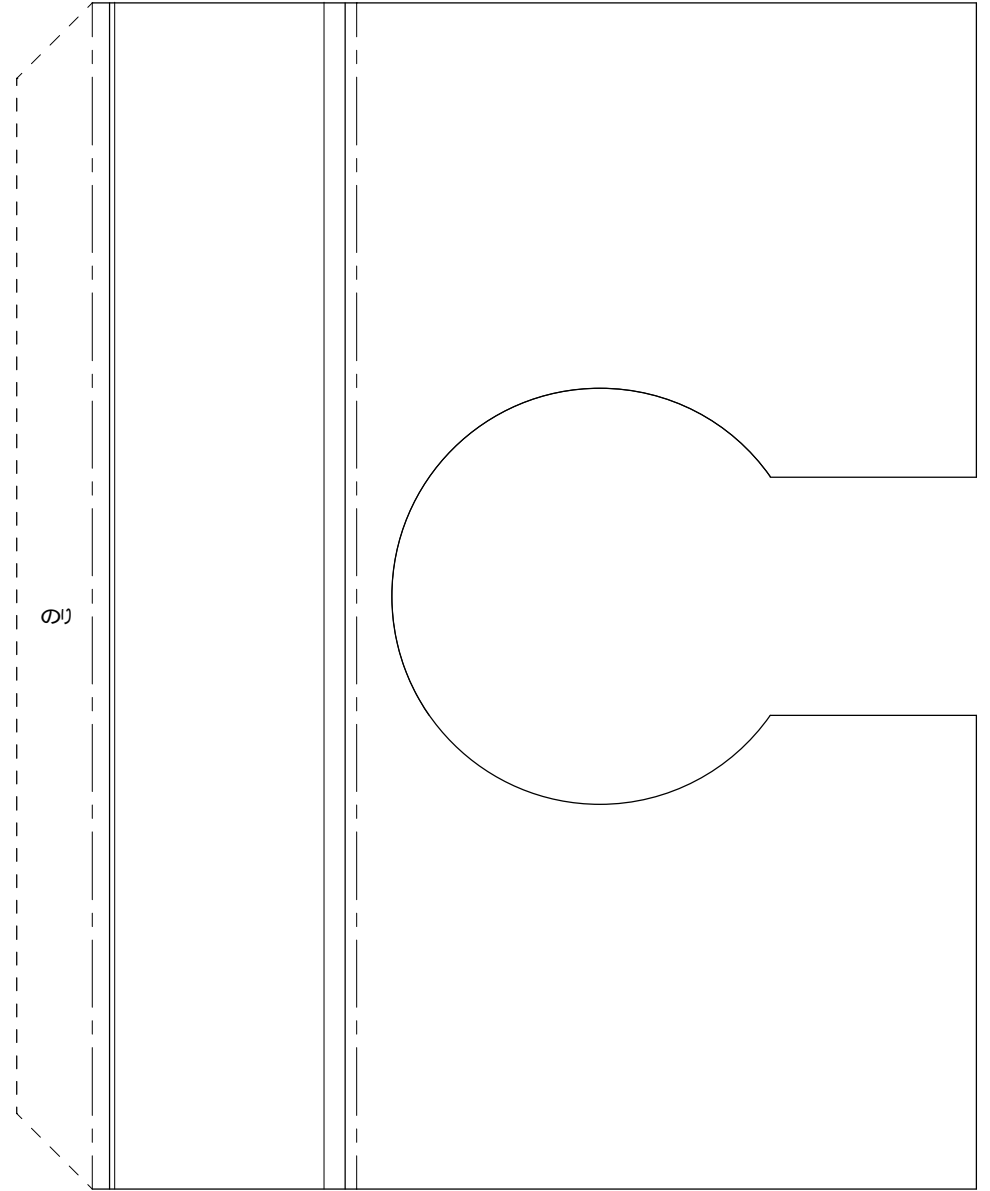

踊り場下部飾り

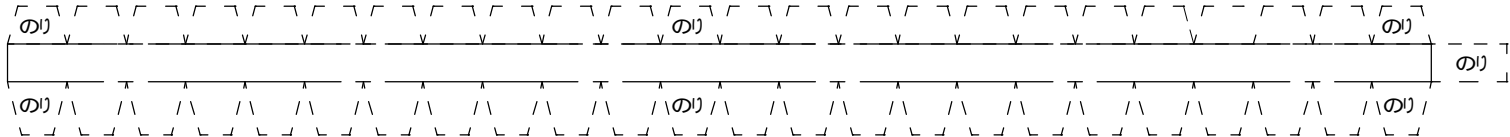

手摺

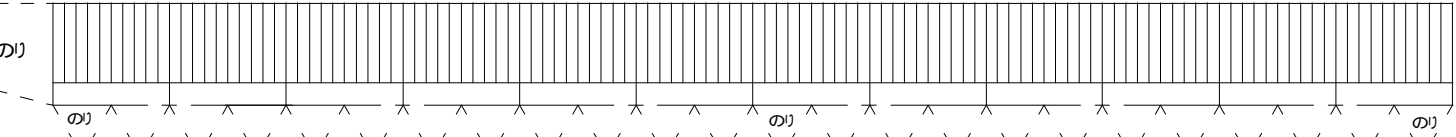

灯ろう

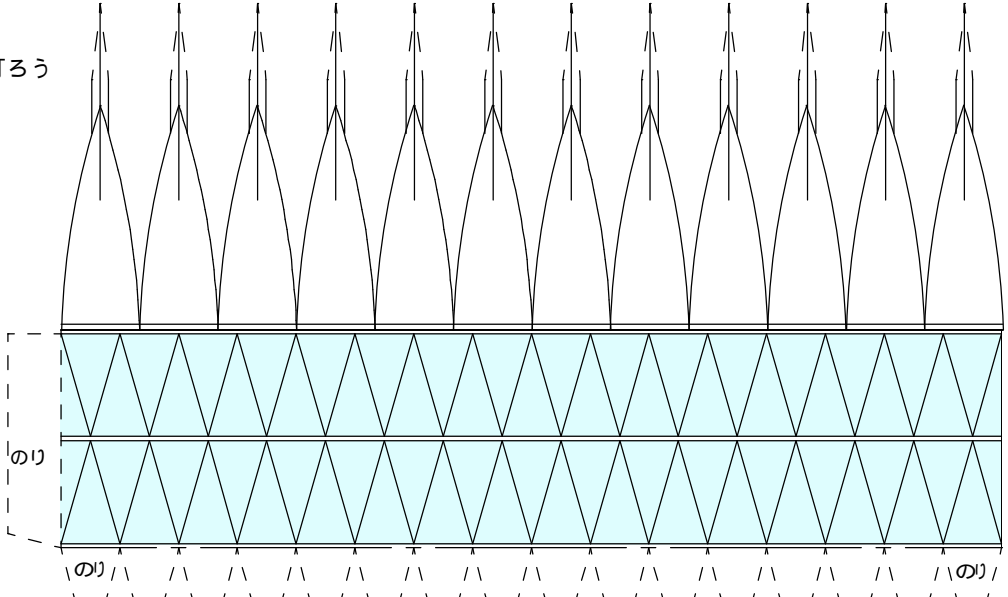

胴壁

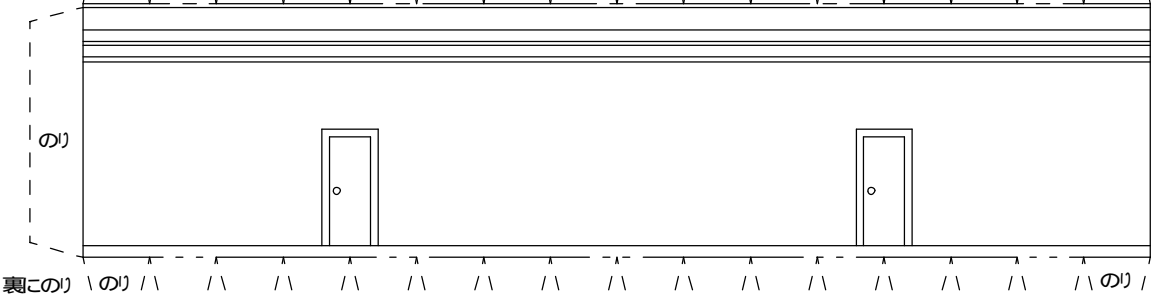

裏このり

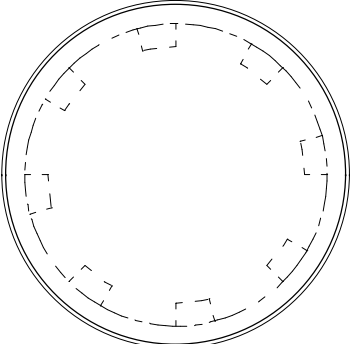

灯ろうひさし

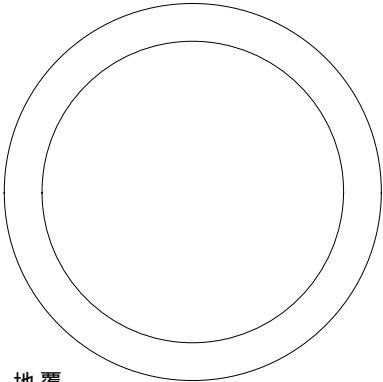

地覆

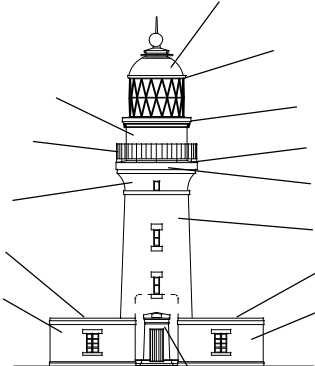

折り曲げ方

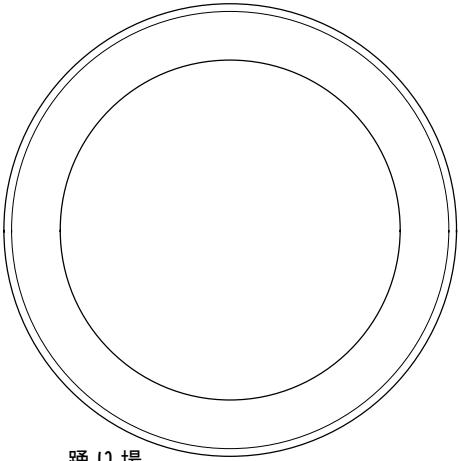
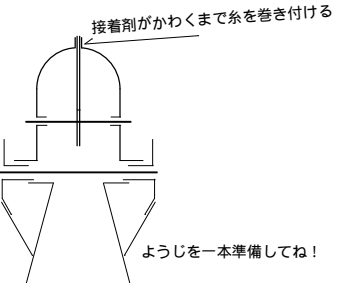

踊り場